



XF-1069GF Fish Finder

Quick Reference V1.0

Before using the product manual (easy operation version), please confirm the menu style of your device. If you use the classic mode, please refer to the operating instructions of the classic mode. If you use the utility mode, please refer to the operating instructions of the utility mode.

The classic mode menu style and the QR code for obtaining the detailed user Operation Manual are as follows:

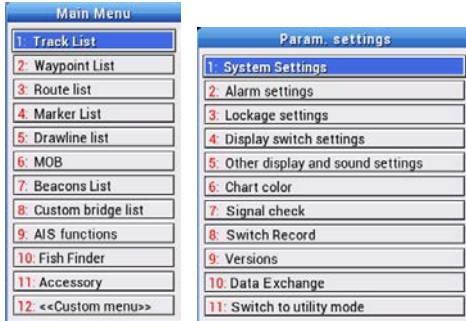

The utility mode menu style and the QR code for obtaining the detailed user Operation Manual are as follows:

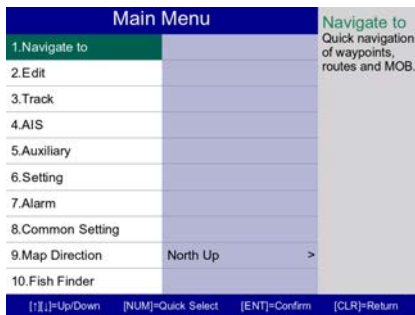

Instructions:

All rights reserved.

Information in this manual is subject to update without notice. XINUO reserves the right to change or update the contents without obligation to notify any person or organization. You can visit the XINUO web site: www.xinuo.com to know the latest updated information and operation of this or other XINUO products.

Warning: Please read through the cautions of the manual to understand the product's cautions and other more important information.

The equipment is not used for navigating directly.

When use the device, please refer to other available navigation sources, including the information from other navigation aids and actual sea conditions, such as: official chart, visual sightings, radar, tides, hydrology, weather and so on.

Statements: Other products and company names involved in this manual are only for identification. Those names may be registered trademarks owned by other company. Version information is displayed in the system only and will not be described in details.

In this manual. "XINUO" and "XINUO TECH" mentioned in this manual all refers to "XINUO information technology(xiamen) corporation limited".

This manual is only for reference, the detail operation should depend on device. It applies to the following models:

XF-1069GF

Notes:

Before turn on this unit, please be sure to read the following precaution avoid the product failure caused by improper operation:

1. Firmly installation of the device is necessary to avoid damage caused by falling down.
2. Please do not use this product without original power adapters. Otherwise, the navigator may not work properly or the performance might be affected or even the equipment will be damaged because of the circuit designs. The rated voltage of this unit is 24V DC, please pay attention to the voltage range.
3. Please do not disassemble the unit by any means or no warranty will be extended.
4. When using or cleaning, be sure to avoid any liquid or other objects falling into the unit as this might cause damage or short circuit.
5. Please do not place the unit and its accessories in a damp environment or under the direct sunlight. Keep the unit in the dry environment.
6. Power supply should be grounded to avoid static and lightning. If the device is not in use, please turn off the unit.
7. If the devices cannot position for a long time, please check the following: The antenna is installed properly; the connection; any forms of interference around the antenna. Before starting of the unit, please make sure the antenna cable joints are intact; there is no short-circuit or open circuit; and follow the correct antenna installation procedure. During the start-up stage, please do not arbitrarily remove the antenna in order to avoid damages to the equipment.
8. When external temperature is too high, the unit may not function properly. Stop using the equipment until the temperature returns to normal and restart the equipment.
9. Avoid direct sunlight on the LCD screen. You can adjust the angle of the screen anytime to get the best visual effects.
10. When hardware failure occurs (e.g. power lines are burned, machine is damaged or foreign bodies fall into the equipment, etc.), please shut down the power and contact with the distributor immediately.
11. Virtually, all data sources might contain some inaccurate or incomplete data. The data are only for your reference and we cannot guarantee any accident, injury or proper damage. All legal responsibility and other obligations will not be taken by XINUO.

Contents

1	Product Introduction.....	1
2	Standard Configuration.....	1
3	Interface Definition.....	2
4	Installation Instruction.....	2
4-1	Installation of GNSS antenna.....	2
4-2	Equipment Installation.....	3
5	Key Description.....	4
6	Operating Instruction.....	8
6-1	Image Partition Ratio.....	8
6-2	Depth Alarm.....	8
6-3	Fish Alarm.....	9
6-4	Gain.....	10
6-5	Range.....	10
6-6	Shift.....	11
6-7	Interference Reduction.....	12
6-8	Noise Reduction.....	12
6-9	Track operation.....	12
6-10	Waypoint Operation.....	13
6-11	Navigation Operation.....	13
6-12	Route Operation.....	14
6-13	Marker Operation.....	15
6-14	Display Mode and Brightness Setting.....	15
6-15	AIS list.....	16
7	Upgrade Operation.....	18
7-1	Format USB to FAT32.....	18
7-2	Download Upgrade File.....	18
7-3	Unzip Files.....	18
7-4	Upgrade Software.....	18
8	Specification.....	19

1 Product Introduction

This device uses a color LCD display with wide viewing angle and high brightness. Built-in BDS and GPS dual-mode positioning module, can provide users with more accurate location, speed, heading and other information. At the same time the equipment built-in fish finder module, the transmit power is 600W and frequency is 50KHz/200KHz. It also supplies intelligent automatically operation modes which are available for selection, such as automatic range adjustment, automatic shift adjustment, automatic gain adjustment, etc. In addition, this device supports multi-language menu display.

2 Standard Configuration

No.	Name of Item	Quantity
1	Display	1
2	Transducer (Optional)	1
3	2m Power cable	1
4	1.2m Data cable	1
5	Screw of ST3*20	4
6	Screw of ST4.2*20	4
7	Knob(M8)	2
8	Larger rubber gasket	4
9	GP80-8M	1
10	Quick Reference V1.0	1

3 Interface Definition

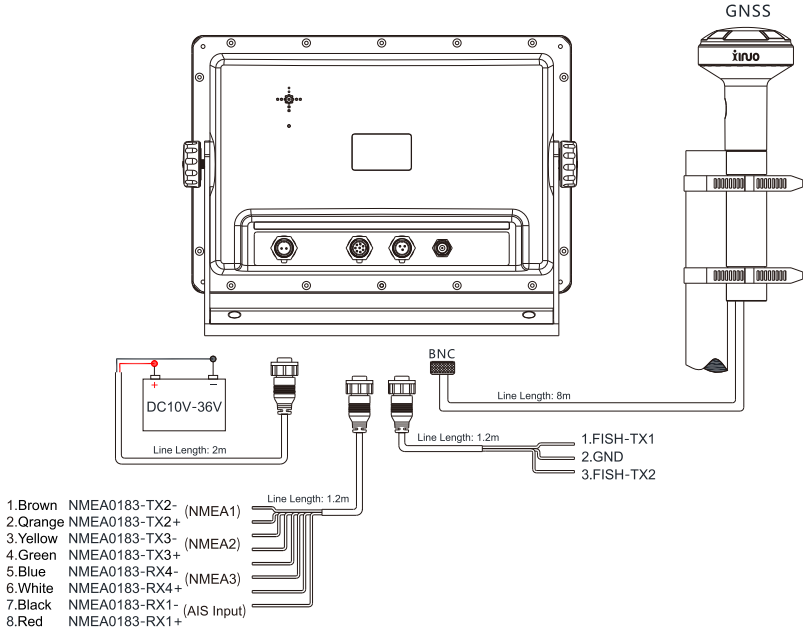

4 Installation Instruction

4-1 Installation of GNSS antenna

GNSS antenna should be without continuous obstacles in the level 360°, elevation 5°- 90°. Apart from more than 3m from the s-band radar and INMARSAT system and other high power antenna beam. Measure A/B/C/D distance data to set up the ship's static parameter.

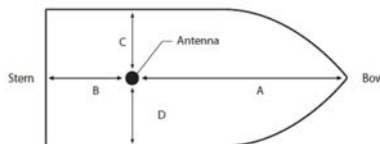

4-2 Equipment Installation



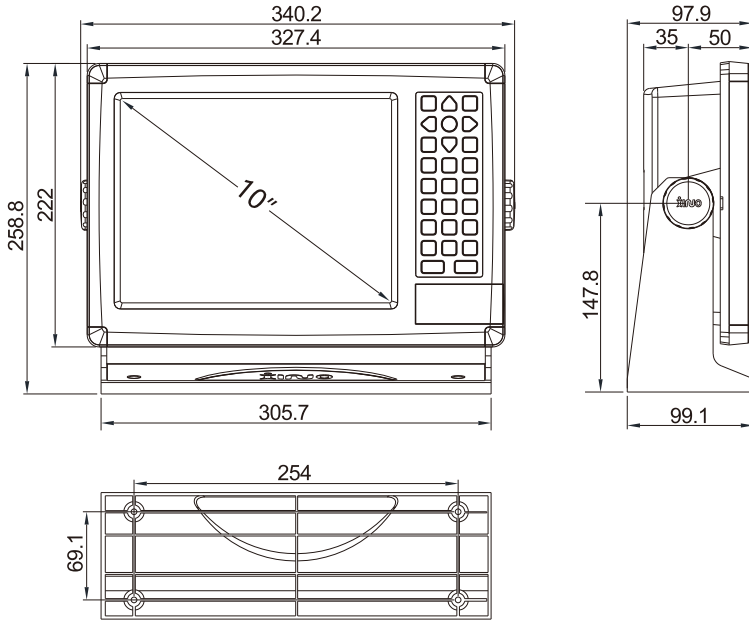



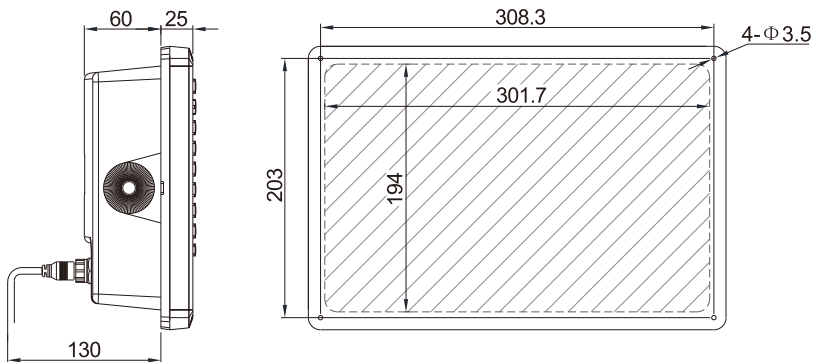

XF-1069GF Counter Mounting [Unit:mm]















Flush Mounting [Unit:mm]





5 Key Description

Key Name	Key Function
【ZOOM IN/ M.RNG↑】 	1) Chart: Adjust chart scale to display a small area with more detail . 2) Fish Finder: Use to reduce the range.
【ZOOM OUT /M.RNG ↓】 	1) Chart: Adjust chart scale to display a larger area to view simple chart. 2) Fish Finder : Use to enlarge the range.
【ARROW】 	1) Chart: Select menu items and also to control cursor movement on the chart. 2) Fish Finder : Adjust the value of depth/sub-sub-range/sub-shift by 【↑】 【↓】 .
【CENTER/ FREQUENCY】 	1) Chart: Use to center the ship position, switch the WPT and route during add route. 2) Fish Finder: Switch frequency (50/200KHz).
【CURSOR /FOCUS】 	1) Chart: Display or hide the cursor. 2) Fish Finder: Switch focus on chart or fish finder.
【PAGE】 	Change the page display of Chart, Chart & Fish Finder, Fish Finder, AIS Data, Compass, etc.
【MENU】 	1) Chart: Press once to 【Main Menu】, press twice to 【Parameters Setting】 under classic mode. 2) Fish Finder: Pop up the 【Fish Finder】 menu.
【CANCEL】 	Cancel option or exit menu. 1) Hide cursor and move chart by the arrow keys on chart , show cursor by press 【CANCEL】 again. 2) Back to chart when switch pages.
【ENTER】 	Confirm current operation.

Key Name	Key Function
⌈ ROTATE /GAIN ↑ ⌋ 	1) Chart: Rotate chart by 90 degree for once press. 2) Fish Finder: Increase the gain value.
⌈ WPT/GAIN ↓ ⌋ 	1) Chart: Press to quickly add WPT. 2) Fish Finder: Reduce the value of gain.
⌈ DIST/STC ↑ ⌋ 	1) Chart: Measure the distance of two point. 2) Fish Finder: Increase the value of STC .
⌈ NEXT-WPT /STC ↓ ⌋ 	1) Chart: [a] Classic Mode: Move to the next WPT during route navigation. In non-route navigation, quickly set the display mode of Normal/Daytime/Night/Cloudy. [b] Utility mode: Move to the next WPT during route navigation. [c] Switch input method of Pinyin, Strokes, Capital English, Lower English and Digital input. 2) Fish Finder: Reduce the value of STC .
⌈ AIS/M.SFT ↑ ⌋ 	1) Chart: Press to quickly call out AIS list. 2) Fish Finder: Reduce the original value of range.
⌈ ROUTE /M.SFT ↓ ⌋ 	1) Chart: Press to quickly add route. 2) Fish Finder: Increase the original value of range.
⌈ COLOR ⌋ 	Modify the display color of track recording and heading line when on track recording.
⌈ AUX/S.SFT ⌋ 	1) Chart: Press to call out 【Auxiliary Function】 menu. 2) Fish Finder: Adjust the value of sub-shift by press ⌈ ↑ ⌋ ⌈ ↓ ⌋ .

Key Name	Key Function
<p>〔GOTO/VRM〕</p> 	<p>1) Chart: Classic mode: Use to call navigation data (WPT, Route, etc); Utility mode: [a] Cursor on : Navigate by WPT: move the cursor+ → press 〔GOTO/DEPTH〕 key to add WPT→press〔ENTER〕 key to start navigate; Navigate by route: move the cursor+→ press 〔GOTO/DEPTH〕 key to add WPT+→ move the cursor+→press 〔GOTO/DEPTH〕 key to add multiple WPT to form a route→ press 〔ENTER〕 key to start navigate. Cancel navigation: current navigation→ press 〔CANCEL〕 key to end navigation→ press 〔ENTER〕 to cancel current navigate. [b] Cursor off : press 〔GOTO/DEPTH〕 key→popup the 〔Menu Go To〕 menu→press 〔GOTO/DEPTH〕 key again→ press 〔CANCLE〕 or 〔GOTO/DEPTH〕 key to select whether to cancel navigation.</p> <p>2) Echo Sounder: Adjust the value of depth line by 〔↑〕 〔↓〕 .</p>
<p>〔MARK〕</p> 	<p>1) Chart: Save cursor position as a mark. 2) Fish Finder: Mark current ship position and draw a vertical line.</p>
<p>〔TRACK〕</p> 	<p>Open the track recording function.</p>
<p>〔PREVIOUS WPT/S.RNG〕</p> 	<p>1) Chart: [a] Classic mode: Move to previous WPT during route navigation. In non-route navigation, used for fast ranging. [b] Utility mode: Move to previous WPT during route navigation.</p>

Key Name	Key Function
[PREVIOUS WPT/S.RNG] 	[c] Switch input method of Pinyin, Storkes, Capital English and Lower English and Digital input. 2) Fish Finder: Adjust the value of sub-range by [↑] [↓] .
[MOB/ EMERGENCY] 	Used for quickly adding MOB to save the current ship position.
[POWER /BRIGHTNESS] 	<p>Classic mode: [a] Press and hold for 3 seconds to power off. [b] Press the button to adjust the brightness.</p> <p>Utility mode: [a] Press and hold for 3 seconds to power off; [b] Press twice [POWER/BRIGHTNESS] to popup the setting menu, press [↑] [↓] to select the desired item, and press [←] [→] to adjust the selected parameter.</p> <p>Two display modes: [a] XINUO-Chart mode: Normal, Daytime, Night, Cloudy. [b] C-MAP mode: Normal, Daytime, Night, Standard, NOAA.</p>

6 Operating Instruction

Note: The 6-1 to 6-8 are the operation instruction of the fish finder. You can change the page of Fish Finder and Chart & Fish Finder by pressing [PAGE]. In the Chart & Fish Finder screen, when the chart screen is activated, all operations only take effect on it. Conversely, it only works for fish finder screen.

6-1 Image Partition Ratio

Image Partition Ratio	<p>On Chart screen: Press [MENU] to enter 【Main Menu】 and select 【Fish Finder】. Select 【Image Partition Ratio】 in 【Fish Finder】 and then press [←] [→] to select image partition mode.</p>
	<p>On Fish Finder screen: Press [MENU] to enter 【Fish Finder】, select 【Image Partition Ratio】 and then press [←] [→] to select image partition mode.</p>
	<p>Note: The setting is available when chart and fish finder are both displayed on screen.</p>

6-2 Depth Alarm

VRM Display	<p>On Chart screen: Press [MENU] to enter 【Main Menu】 and select 【Fish Finder】. Select 【VRM Display】 in 【Fish Finder】 and then press [←] [→] to select the VRM display setting mode.</p>
	<p>On Fish Finder screen: Press [MENU] to enter 【Fish Finder】, select 【VRM Display】 and then press [←] [→] to select the VRM display setting mode. Note: If the VRM is set to hide, it will be show only press the [GOTO/VRM].</p>

Depth Alarm	<p>On Chart screen: Press [MENU] to enter 【Main Menu】 and select 【Fish Finder】. Select 【Depth Alarm】 in 【Fish Finder】 and then press [←] [→] to set the depth alarm .</p>
	<p>On Fish Finder screen: Press [MENU] to enter 【Fish Finder】 , select 【Depth Alarm】 and then press [←] [→] to set the depth alarm.</p>

6-3 Fish Alarm

Fish Alarm On-off	<p>On Chart screen: Press [MENU] to enter 【Main Menu】 and select 【Fish Finder】 . Select 【Fish Alarm On-off】 in 【Fish Finder】 and then press [←] [→] to set on/off.</p>
	<p>On Fish Finder screen: Press [MENU] to enter 【Fish Finder】 , select 【Fish Alarm On-off】 and then press [←] [→] to set on/off.</p>
Fish Alarm Level	<p>On Chart screen: Press [MENU] to enter 【Main Menu】 and select 【Fish Finder】 . Select 【Fish Alarm Level】 in 【Fish Finder】 and then press [←] [→] to set fish level alarm.</p>
	<p>On Fish Finder screen: Press [MENU] to enter 【Fish Finder】 , select 【Fish Alarm Level】 and then press [←] [→] to set fish level alarm.</p>
Fish Alarm Color	<p>On Chart screen: Press [MENU] to enter 【Main Menu】 and select 【Fish Finder】 . Select 【Fish Alarm Color】 in 【Fish Finder】 and then press [←] [→] to set fish alarm color.</p>

Fish Alarm Color	<p>On Fish Finder screen: Press [MENU] to enter 【Echo Sounder】 , select 【Fish Alarm Color】 in 【Echo Sounder】 , and then press [←] 、 [→] to set fish alarm color.</p>
------------------	---

6-4 Gain

Setting Gain Mode	<p>On Chart screen: Press [MENU] to enter 【Main Menu】 and select 【Fish Finder】 .Select 【Gain】 in 【Fish Finder】 and then press [←] [→] to set gain mode.</p>
	<p>On Fish Finder screen: Press [MENU] to enter 【Fish Finder】 , select 【Gain】 and then press [←] [→] to set gain mode.</p>
Gain Setting	<p>Manual mode: Press [ROTATE/GAIN↑] to increase the value of gain. Press [WPT/GAIN↓] to reduce the value of gain.</p>
	<p>Auto mode: Gain value will be changed automatically . At this time, press [ROTATE/GAIN↑] or [WPT/GAIN↓] to manually adjust the gain is invalid.</p>
STC Setting	<p>On Fish Finder screen: Press [DIST/STC ↑] to increase the value of STC. Press [→•/STC↓] to reduce the value of STC.</p>

6-5 Range

Setting Range mode	<p>On Chart screen: Press [MENU] to enter 【Main Menu】 and select 【Fish Finder】 . Select 【Range】 in 【Fish Finder】 and then press [←] [→] to set range mode.</p>
	<p>On Fish Finder screen: Press [MENU] to enter 【Fish Finder】 , select 【Range】 and then press [←] [→] to set range mode.</p>

Range Setting	<p>Manual mode: Press [M.RNG ↑] to narrow the range of the current image. Press [M.RNG ↓] to wide the range of the current image.</p>
	<p>Auto mode: Range value will be changed automatically . At this time, press [M.RNG ↑] or [M.RNG ↓] to manually adjust the range is invalid.</p>

6-6 Shift

Setting Shift Mode	<p>On Chart screen: Press [MENU] to enter 【Main Menu】 and select 【Fish Finder】 . Select 【Shift】 in 【Fish Finder】 and then press [←] [→] to set shift mode.</p>
	<p>On Fish Finder screen: Press [MENU] to enter 【Fish Finder】 , select 【Shift】 and then press [←] [→] to set shift mode.</p>
Shift Setting	<p>Manual Mode: Press [AIS /M.SFT↑] to reduce the original value of range. Press [ROUTE/M.SFT↓] to increase the original value of range.</p>
	<p>Automatic Mode: The original value of range will be changed automatically . At this time, press [AIS/M.SFT↑] or [ROUTE/M.SFT↓] to manually adjust the range is invalid.</p>

6-7 Interference Reduction

Interference Reduction	<p>On Chart screen: Press [MENU] to enter 【Main Menu】 and select 【Fish Finder】 .Select 【Interference Reduction】 in 【Fish Finder】 and then press [←] [→] to set the value of it.</p>
------------------------	--

Interference Reduction	<p>On Fish Finder screen: Press [MENU] to enter 【Fish Finder】 , select 【Interference Reduction】 and then press [←] [→] to set the value of it.</p>
------------------------	--

6-8 Noise Reduction

Noise Reduction	<p>On Chart screen: Press [MENU] to enter 【Main Menu】 and select 【Fish Finder】 . Select 【Noise Reduction】 in 【Fish Finder】 and then press [←] [→] to set noise reduction mode.</p>
	<p>On Fish Finder screen: Press [MENU] to enter 【Fish Finder】 , select 【Noise Reduction】 and then press [←] [→] to set noise reduction mode.</p>

6-9 Track operation

Track Record	<p>Press [TRACK] to open or close track recording.</p>
Track Color	<p>Open the track record and then press [COLOR] to set color of the current track (eight colors are available).</p>
Delete Track	<p>Classic mode: Press [MENU] to enter 【Main Menu】 , select 【Track List】 and press [ENTER] to enter the menu. Press the arrow keys to select the track that needs to delete and then select 【Delete Track】 in 【Track Operation】 to delete it.</p> <p>Utility mode: Press the arrow keys to move the cursor and then select the track that needs to delete. When the selected track is flashing red and green, press the [CANCEL] and then delete it after selecting confirm in pop-up prompt window.</p>

6-10 Waypoint Operation

Add WPT	On the chart, press the arrow keys to move the cursor and then add a waypoint by pressing [WPT] .
Delete WPT	<p>Classic mode: On the chart, press the arrow keys to move the cursor to select the waypoint that needs to delete and then press [ENTER] to enter Waypoint Operation . Select Delete Waypoint to delete the selected waypoint.</p>
	<p>Utility mode: On the chart, press the arrow keys to move the cursor and then select the waypoint that needs to delete. When the selected track is flashing red and green please press the [CANCEL] and then delete it after selecting confirm in pop-up prompt window.</p>

6-11 Navigation Operation

Route Navigation	<p>Classic mode: [a] Press the arrow keys to move the cursor to select a waypoint and then press [ENTER] to pop up the Waypoint Operation and select Call Waypoint. [b] Press [GOTO] to pop up Call navi data and press the arrow keys to enter the input box , then press [ENTER] after input the number of the navigation one .</p>
	<p>Utility mode: [a] When the cursor is opened,move cursor to the desired waypoint by pressing arrow keys and then press [GOTO] to enter navigation. [b] When the cursor is closed, press [GOTO] to enter Menu Go To . Select Waypoint to enter Waypoint List and then press the arrow keys to select desired waypoint. At last press [ENTER] to start navigation.</p>

Route Navigation	<p>Classic mode: Press [GOTO] to pop up 【Call navidata】 and press [←] [→] to select the navigation mode. Then enter the input box and press [ENTER] after input the number of the navigation one.</p>
	<p>Utility mode: Press the arrow keys to move the cursor and then press [GOTO] to add waypoint. Repeat the operation to add multiple way points to form a route and then press [ENTER] to start navigation.</p>

6-12 Route Operation

Add Route	<p>Classic mode: Press [ROUTE] to enter the status of add and move cursor to the location that desired waypoint by pressing arrow keys. Then press [ENTER] to add waypoint . Press the arrow keys and repeat the operation to add multiple way points to form a route and then press [ROUTE] to save it.</p>
	<p>Utility mode: Press the arrow keys to move the cursor to select the location of the waypoint and then press the [ROUTE] to add. Then press the arrow keys and repeat the operation to add multiple way points to form a route . At last press [CANCEL] to save the route.</p>
Delete Route	<p>Classic mode: Press [MENU] to enter 【Main Menu】 and then enter 【Route List】 to select the route to be deleted. Then press [ENTER] to pop up 【Route Operation】 menu and select 【Delete Route】 . At last select 【Yes】 in the pop up prompt window.</p>
	<p>Utility mode: Press the arrow keys to move the cursor and then select the route to be deleted. When the selected route is flashing red and green please press the [CANCEL] and then delete it after selecting confirm in pop-up prompt window.</p>

6-13 Marker Operation

Add Marker	On the chart, press the arrow keys to move the cursor and press the [MARK] to add the marker at the selected position .
Delete Marker	<p>Classic mode: Press the arrow keys to move the cursor and press [ENTER] to select the marker point to be deleted. Then select 【Delete Marker】 in the 【Marker Operation】 and press [ENTER] to delete it.</p>
	<p>Utility mode: Press the arrow keys to move the cursor and then select the marker point to be deleted. When the selected marker is flashing red and green please press the [CANCEL] and then delete it after selecting confirm in pop-up prompt window.</p>

6-14 Display Mode and Brightness Setting

Display Mode	<p>Classic mode: On the chart and non-route navigation, press [→ •] to pop up the 【Scene Setting】 and then press the arrow keys to select mode.</p>
	<p>Utility mode: Press [POWER] twice to call out 【Device Settings and Display Mode】 and press [↑] [↓] to select item, then press [←] [→] to select mode.</p>
Brightness Adjustme	<p>Classic mode: Click the [POWER] to adjust the brightness.</p>
	<p>Utility mode: Press [POWER] twice to call out 【Device Settings and Display Mode】 and press [↑] [↓] to select item, then press [←] [→] to set the value of the selected item.</p>

6-15 AIS list

<p>AIS Operation</p>	<p>Classic mode: On the chart,when the cursor moves to the AIS vessel to pop up the AIS information. Then press [ENTER] to pop up the AIS menu, you can select 【Show Track/Details/Add Monitoring/Start Trace】 .</p>
	<p>Utility mode: On the chart,when the cursor moves to the AIS vessel to pop up the AIS information. Then press [ENTER] to pop up the AIS operation menu, you can select 【Join Monitoring/Send Message/Start Trace/Track Display/Details】 .</p>
<p>AIS Sort Function</p>	<p>Classic mode: Press [MENU] to enter 【Main Menu】 and select 【AIS functions】 . Select 【AIS vessel information】 in the AIS function menu and then press [ENTER] to enter AIS list. Press [MENU] to pop up the AIS operation menu and then select 【Sort】 .You can sort MMSI, Distance,SOG and Name in ascending or descending order.</p>
	<p>Utility mode: Press [MENU] to enter 【Main Menu】 and then select 【AIS】 . Press [ENTER] to pop up the AIS function menu and then select 【AIS List】 . Press [MENU] to pop up the AIS operation menu and then select 【Sort】 . You can sort MMSI, Distance,SOG and Name in ascending or descending order.</p>
<p>View the details of AIS vessel</p>	<p>Utility mode: Press [MENU] to enter 【Main Menu】 and select 【AIS】 . Press [ENTER] to pop up the AIS function menu and then select 【AIS List】 . Select an AIS target in AIS list and press [MENU] to pop up the AIS operation menu, then select 【Detail】 and press [ENTER] to check the detail information.</p>

View AIS vessel on the chart	<p>Classic mode: Press [MENU] to enter 【Main Menu】 and select 【AIS function】 , then select 【AIS vessel information】 . Select an AIS target in AIS list and then select 【View】 in AIS operation menu. Press [ENTER] and the screen will turn to the position of the vessel on the chart automatically.</p> <p>Utility mode: Press [MENU] to enter 【Main Menu】 and select 【AIS】 . Press [ENTER] to pop up the AIS function menu and then select 【AIS List】. Select an AIS target in AIS list and then select 【View】 in AIS operation menu. Then press [ENTER] and the screen will turn to the position of the vessel on the chart automatically.</p>
Correct the Chinese ship name	<p>Classic mode: Press [MENU] to enter 【Main Menu】 and select 【AIS vessel information】 in the AIS menu. Press [ENTER] to pop up the AIS list and then select an AIS target. Select 【Correct ship name】 and press [ENTER] to pop up the edit window , then save the information after modify.</p>

7. Upgrade Operation

You can upgrade software by using USB or SD card. The upgrade will keep the original data such as track, route. You can upgrade the software following below steps.

7-1 Format USB to FAT32

7-2 Download Upgrade File

You can find the upgrade link on the official website of Xinuo Information Technology(xiamen) Corporation Limited or the Wechat Public Number (or obtained the package from the dealer) to download the upgrade file.

7-3 Unzip Files

7-4 Upgrade Software

- ① Turn off the device.
- ② Insert the USB or SD card into the USB/SD card slot.
- ③ After restarting the device, the screen will automatically display the upgrade process and information, which indicate that it is upgrading.
- ④ When the upgrade is complete, there will be a prompt window display on screen. Then please unplug the USB or SD card and restart the device again.

After completing these steps, the device upgrade is successful.

8 Specification

Display Unit	
Screen Type	Color TFT LCD
Screen Size	10.4 inch
Display Resolution	800× 600
Screen Brightness	300cd/m ²
Chart	Classic mode: XINUO Chart
	Utility mode: XINUO Chart and C-MAP Chart
Power	DC 10V-36V
Power consumption	Less than 14W (Voltage : 24V)
Fish Finder Parameters	
Transmit Frequency	50/200KHz
Transmit power	600W
Scene	Single, Double, Frequency/Zoom, Frequency/Bottom, Frequency/B.D.
A Scope	User can switch on/off the A scope
Echo Color Tone	Available in monochrome,8 colors,16 colors.
Echo Single Level	1,2,3,4
Echo Background	Blue, Black, White
Decoloration	Provide 4 weaker echo colors and can be closed.
White Line	Highlight the display of the bottom of the seabed: 1, 2, 3, 4
Image Speed	0, 1, 2, 3, 4, 5, 6, 7, 8
Noise Reduction	Low, Medium, High
Depth Unit	Meter, FT, FM
Depth Alarm	Depth-water, Low-water
VRM Display	Show, Hide, Auto
Fish Alarm Color	1L(Weak) 2L 3L 4L(Medium) 5L 6L 7L(Strong)
Fish Alarm Level	Small, Medium, Large
Sonic Speed Set	Adjustable range:1400-1600m/s.
Draft Set	Adjustable 0.1 unit at a time, adjustable range: 0.0-19.9.
The output statement of water depth	\$XXDPT(NMEA-0183)

Environmental		
Working Temperature	-15°C ~ +55°C	
Storage Temperature	-20°C ~ +70°C	
Waterproof Level	IPX5	
GNSS		
GNSS Receiver	32 Channels	
Receive Frequency	L1,1575.42MHz; B1,1561.098MHz	
Accuracy	GPS&BDS	2.5m (CEP50% open sky)
	GPS	3m (CEP50% open sky)
	BDS	5m (CEP50% open sky)
Speed Accuracy	0.1m/s (50%@10m/s)	
Time to First Fix	Cold Start: <32s 、 Hot Start: <1s	
Coordinate Systems	WGS-84 (and others)	

YS01E01000



Xinuo Information Technology (Xiamen) Corporation Limited

Address: Unit 2001, 1 Chengyi North Street (B04), Software Park III, Xiamen, China

Tel: +86-592-3300300 Fax: +86-592-3300310 Hotline: 400-8868-592

Web: <http://www.xinuo.com> Email: info@xinuo.com

